

EK-S25

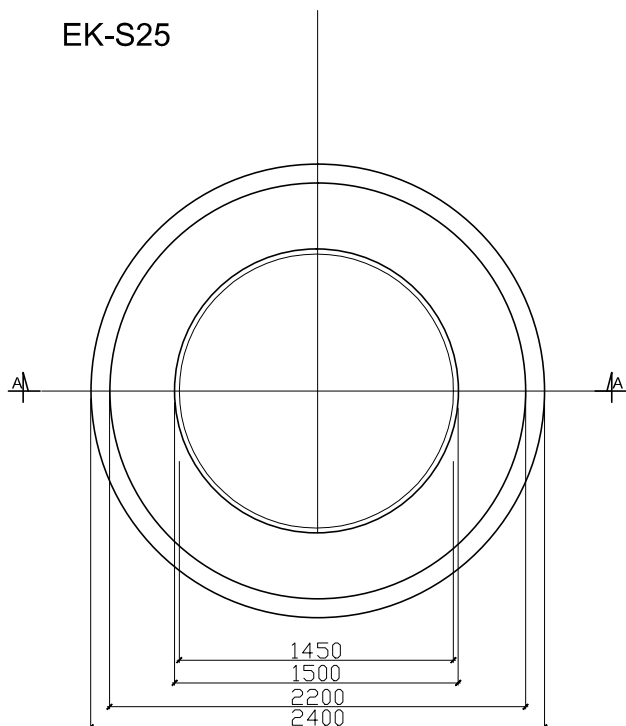

WIDOK Z GÓRY

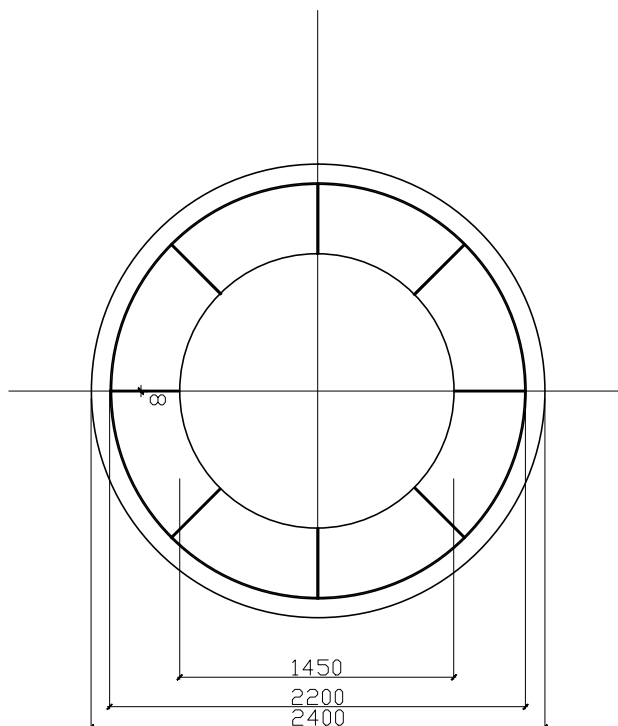

RZUT

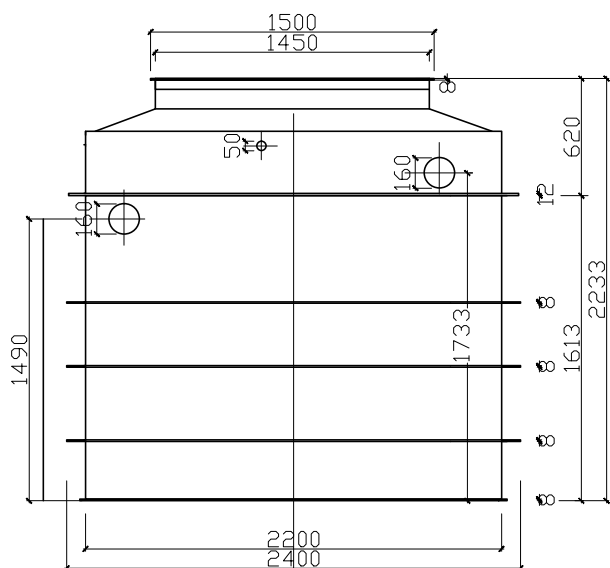

WIDOK Z BOKU

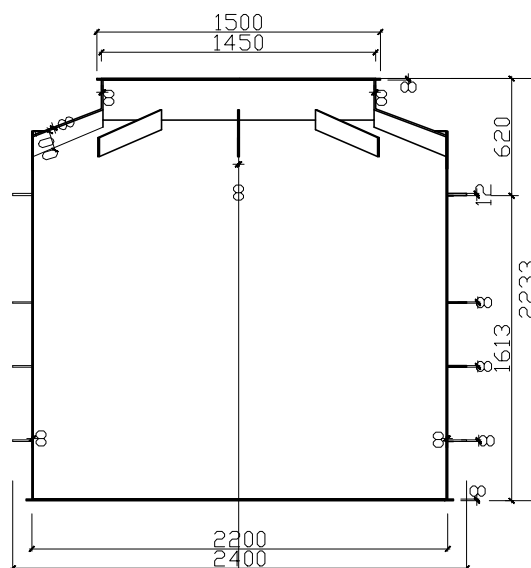

PRZEKRÓJ A-A